

**General Specifications - Model ABC15.0-XXD20Y**

<b>Input Voltage</b>	208/240/480/600 delta connection (4 wire)
<b>Output Voltage</b>	208/120 wye (5 wire)
<b>Frequency</b>	60 Hz. only
<b>Continuous Capacity</b>	15 kVA
<b>BTU/Hr. Output</b>	1536
<b>Efficiency</b>	≥ 97% (at full load, unity power factor)
<b>Step Load Change</b>	± 0.8% (at unity power factor)
<b>Noise Rejection</b>	With unit under power and the isolation transformer configured for a transformation ratio of 1:1 and with an ANSI/IEEE C62.41, Category A pulse applied either normal mode or common mode at the input, the noise output voltage will be less than 10 volts normal mode and less than .5 volts (½ of one volt) common mode in all four quadrants (CM-NM, NM-NM, CM-CM, NM-CM).
<b>Surge Voltage Withstand</b>	Tested under power to ANSI/IEEE C62.41, Category A & B (formerly IEEE587-1980). Power conditioner tested to withstand up to 6000 volts @ 3000 amp ringwave and unipolar impulse.
<b>Construction Materials</b>	Transformer wires are copper and insulated with Class H materials. Windings are insulated with Nomex paper insulation before vacuum varnishing. Internal wiring is a minimum of 200 degree C rated and sleeved with Class H materials. Grain oriented silicon iron cores are constructed using 14 mil. laminations interleaved one to one. Eddy currents are minimized and external magnetic fields are below 0.1 oersted (at 12 inches distance in any direction). <b>Unit is RoHS compliant.</b>
<b>Physical Dimensions H x W x D - inches (mm.)</b>	26 x 18 x 30 (660 x 457 x 762)
<b>Weight in lbs. (kg.)</b>	546 (248)

**Input Connection Requirements\***

Input Voltage	Input Current (FLA)	Supply Breaker Rating @ Switchgear	AIC (Current Interrupt Capacity of Input Circuit Breaker)	Minimum Input Conductor Size (includes ground)	Input Lug Maximum Wire Size
208	42	60	25 kAmps	6 AWG	2 AWG
240	36	45	25 kAmps	8 AWG	2 AWG
480	18	25	25 kAmps	10 AWG	2 AWG
600	15	20	25 kAmps	12 AWG	2 AWG

\* Supply breaker ratings are determined by NEC guidelines limiting breaker loading to 80% of rated breaker capacity. Calculations for supply breaker recommended ratings are based on input full load amps multiplied by 1.25 and then selecting the next larger standard size breaker. Wire sizes shown in the input and output connection tables of this specification sheet are the minimum sizes allowed by electrical codes for each supply breaker rating and are taken from the 2002 National Electrical Code Article 310.16 table references for use in 90° C installations.



1450 Lakeside Drive, Waukegan, IL 60085  
 (847) 596 - 7000 - (Outside Illinois 800 - 369-7179), Fax (847) 596 - 7100  
 www.powervar.com

### Output Connection Requirements\*

Output Voltage	Output Current (FLA)	Minimum Output Conductor Size (includes ground)	Output Lug Maximum Wire Size
208/120	42	8 AWG	2/0

### Input Voltage Changes

This power conditioner is equipped with a fixed input circuit breaker. If changes are required to the input voltage setting of the power conditioner, it will be necessary to replace the fixed breaker and set input voltage taps appropriately per the following diagram. Please contact POWERVAR Technical Support to order a replacement breaker and for assistance in making any required changes.

VAC	Connect each phase
208	H1 to H3-4, H2 to H1-4 and H3 to H2-4
240	H1 to H3-3, H2 to H1-3 and H3 to H2-3
480	H1 to H3-2, H2 to H1-2 and H3 to H2-2
600	H1 to H3-1, H2 to H1-1 and H3 to H2-1

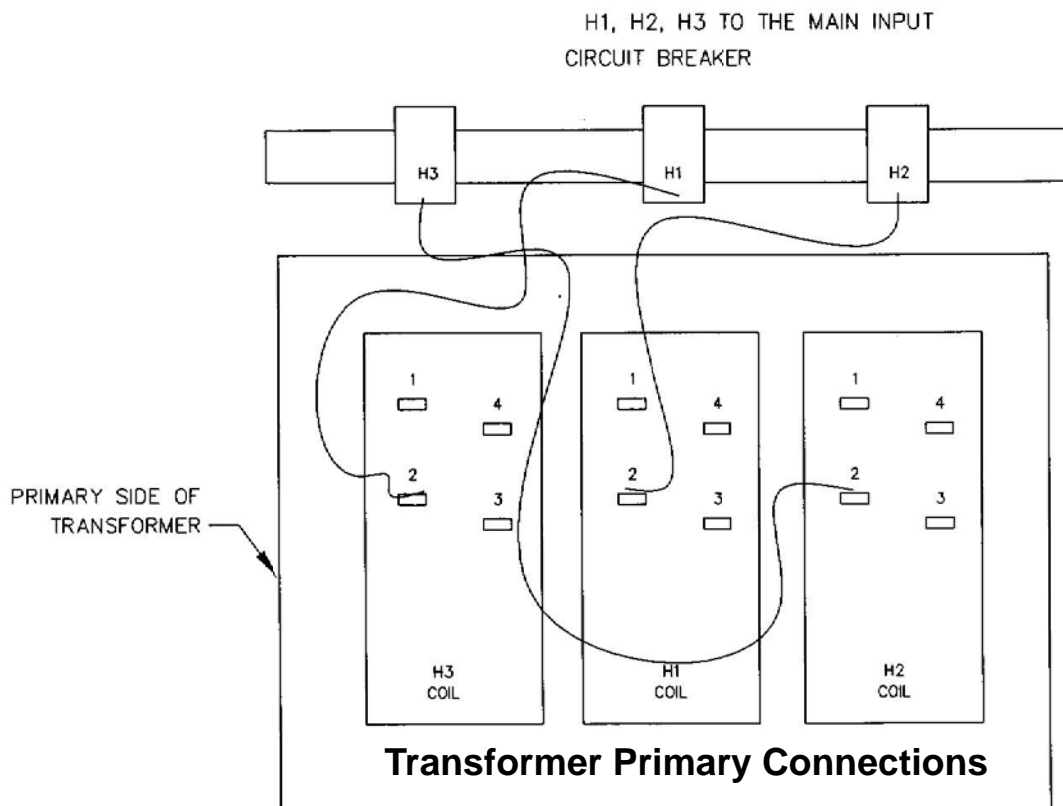

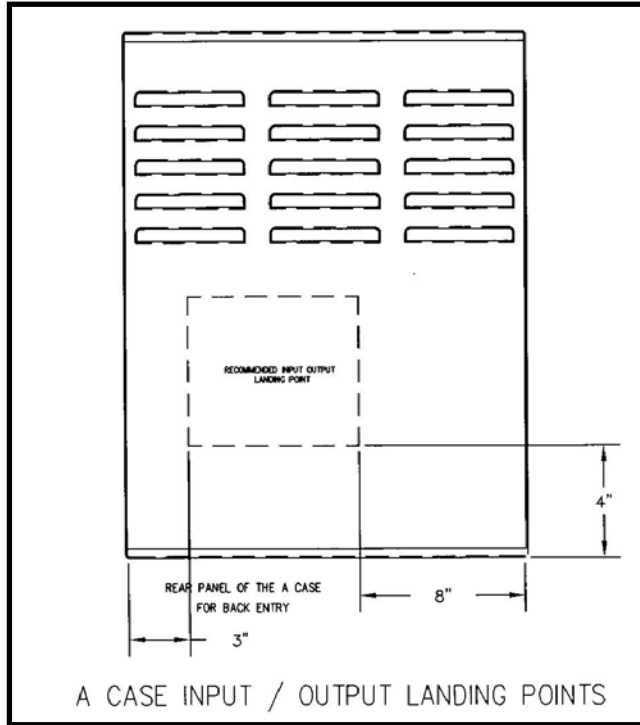

1.5" Sq. x .187" Wall Tube is welded to bottom panel of cabinet frame

5/16-18 x 2.5" Grade 5 Bolts

3/8-16 Grade 5 Bolt

18.40

14.00

29.62

35.32

12.78

6.16

19.64

### Seismic Anchorage Data

Max total weight in lbs. (kg.) = 450 (204.5)

Max. weight per foot in lbs. (kg.) = 466 (211.8)